

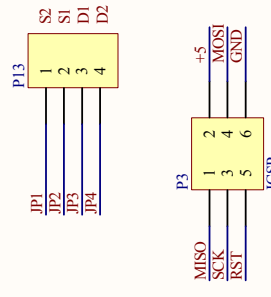

rhydoLABZ

PROTOSHIELD

Rev: V1

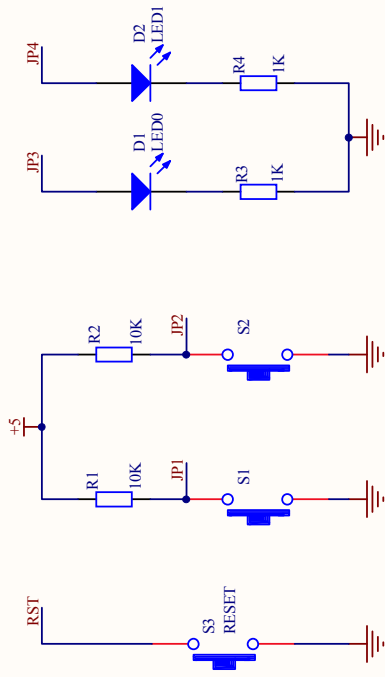
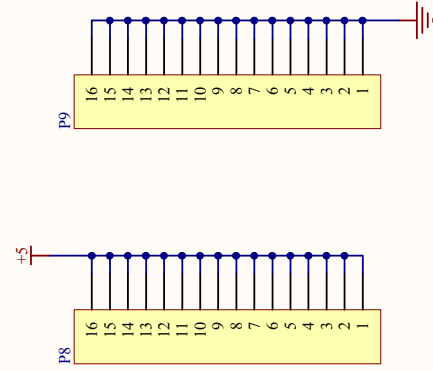
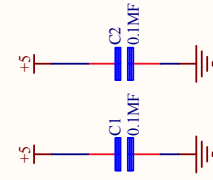
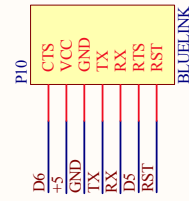
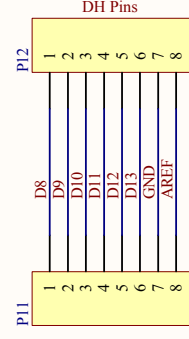
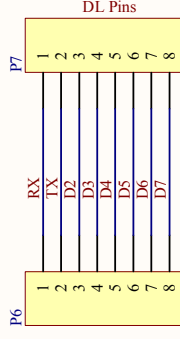
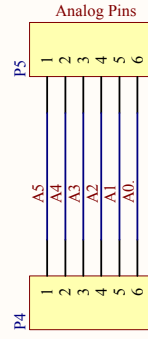
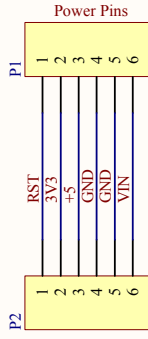

Title		PROTOSHIELD	
Size	Number	Revision	V1
A4			
Date:	10/31/2012	Sheet of	4
File:	D:\rhydolabz\Sheet1_SchDoc	Drawn By:	